

TECHNICAL RECOMMENDATIONS:

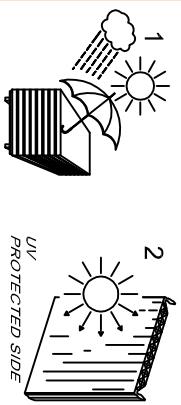

1. PROTECT THE SHEETS BY THE SUN AND RAIN
2. INSTALL THE SHEETS ALWAYS WITH THE UV PROTECTED LAYER FACING OUTWARDS

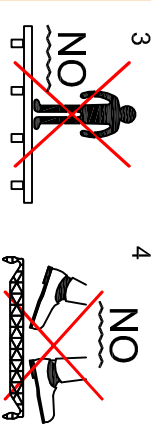

3. MULTIWALL POLYCARBONATE SHEETS CAN NOT BE WALKED UPON
4. DO NOT WALK ONTO THE SHEETS AT ANY TIME. FOLLOW SAFETY REGULATIONS AND SAFE METHODS OF INSTALLATION

POLYCARBONATE SUFFER THE CHEMICAL ATTACK OF SOME PRODUCTS. THEREFORE:

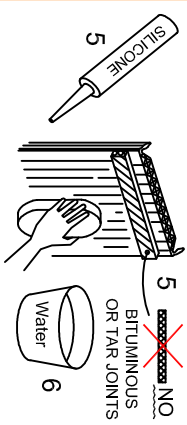

5. USE ONLY COMPATIBLE CLEAR SILICONE FOR THE SEALING
6. USE ONLY WATER AND MILD DETERGENTS FOR THE CLEANING

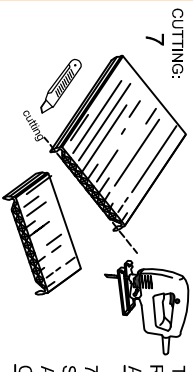

THE SHEETS ARE SUPPLIED TO THE EXACT LENGTH REQUIRED EITHER THERMOSEALED OR SEALED WITH AN ALUMINIUM FOIL TAPE AT THE ENDS

7. CUTTING OF THE SHEETS CAN BE EXECUTED ON SITE BY MEANS OF A HACK SAWING MACHINE (1) OR OF A CUTTER (2). SEAL THE OPEN CELLS AFTER THE CUTTING

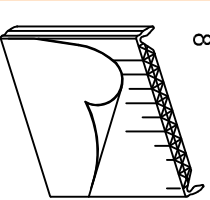

8. TAKE OFF THE PROTECTIVE FILM BEFORE THE INSTALLATION

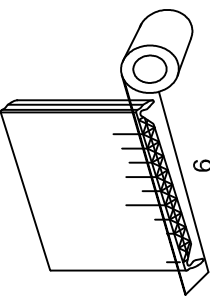

9. SEAL THE OPEN CELLS WITH AN ADHESIVE ALUMINIUM TAPE

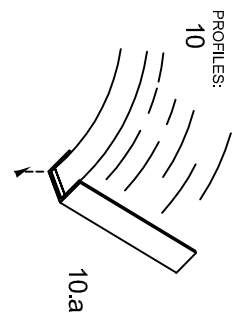

10. PROTECT THE SEALING WITH AN UPPER AND A LOWER PROFILE 10.a LOWER PROFILES MUST BE DRILLED FOR WATER DRAINING

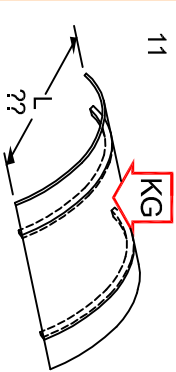

11. LOADINGS AND SPACINGS CHECK OUR TECHNICAL LITERATURE TO DETERMINE LOADING AND SPACING OF THE WHOLE SYSTEM

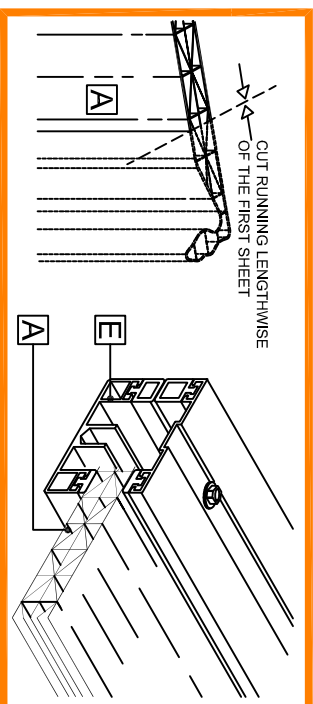
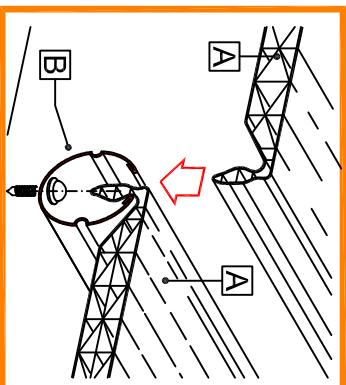
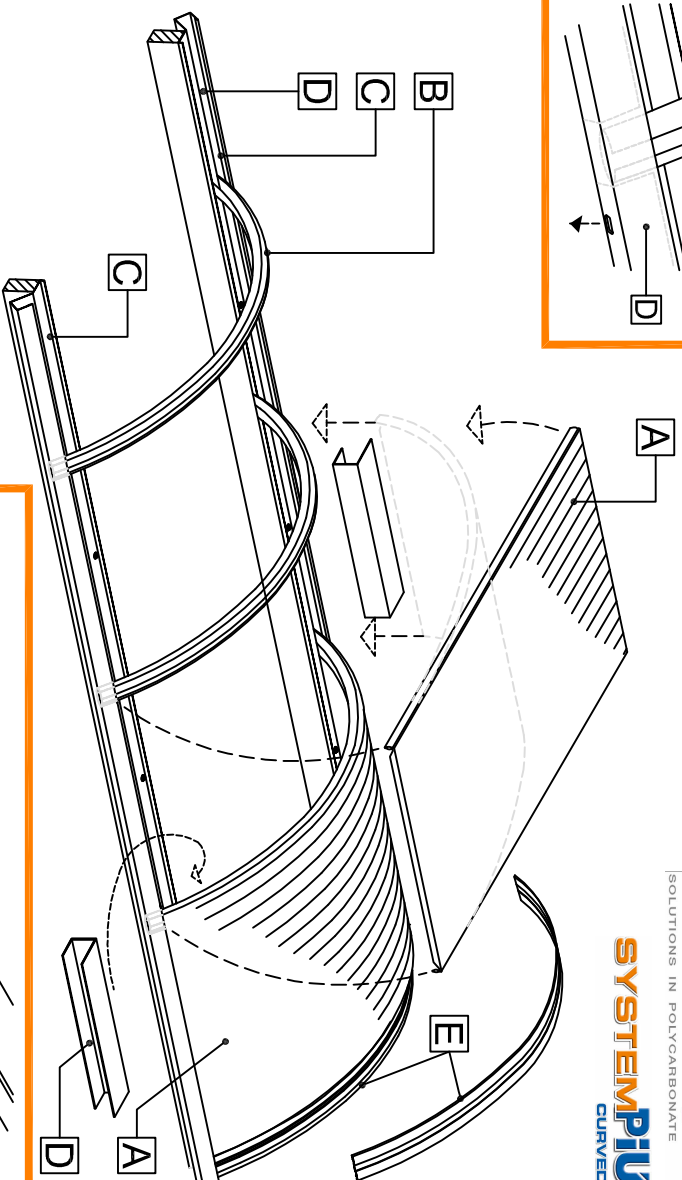
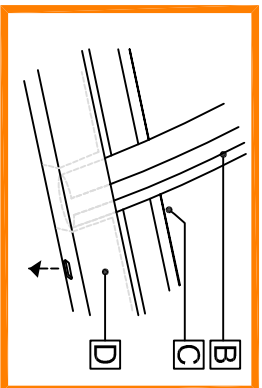

B1 Ø34mm JOINING CHANNEL

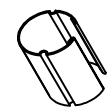

B2 Ø55 mm JOINING CHANNEL

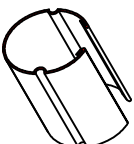

A SYSTEMPIU' 655/12-16-20 -665 PASSO LASTRA

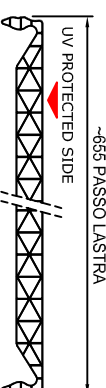

D COMPENSATION PROFILE



C SIDE PROFILE

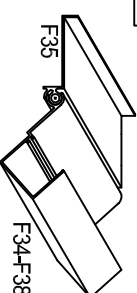

E CURVED END PROFILE

